

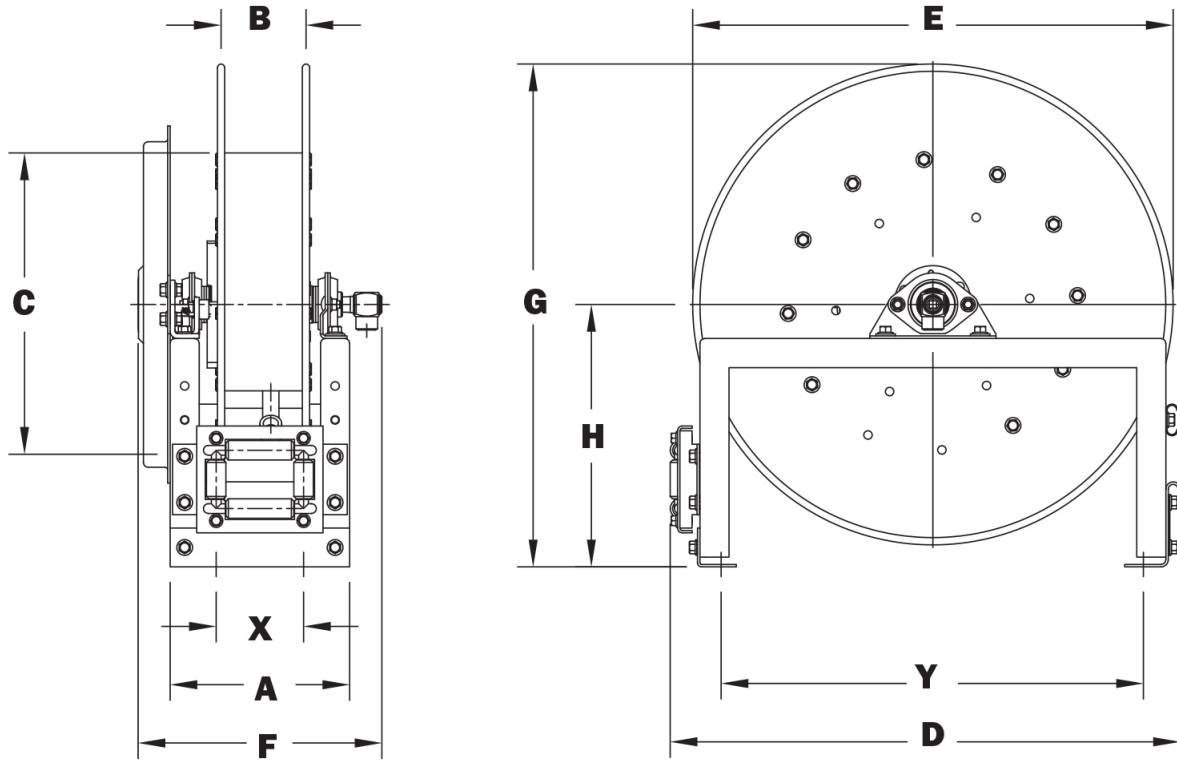











# 700 Spring Rewind Reels



MODEL	REEL CAPACITY (ft / lbs)			REEL DIMENSIONS (inches)										
	Size	Length	Weight	A	B	C	D	E	F	G	H	X	Y	Relative Size
716-23-24-15.5J	3/8 ID	65	79	9.25	4	15.5	24.5	22.75	12.62	23.88	12.5	4.5	20	
716-23-24-15.5J	1/2 ID	65	79	9.25	4	15.5	24.5	22.75	12.62	23.88	12.5	4.5	20	
716-23-24-15.5G	3/8 ID	75	94	9.25	4	15.5	24.5	22.75	12.62	23.88	12.5	4.5	20	
716-23-24-15.5G	1/2 ID	65	94	9.25	4	15.5	24.5	22.75	12.62	23.88	12.5	4.5	20	
716-25-26-15.5B	3/8 ID	75	90	9.25	4	15.5	26.25	24.75	12.62	25.88	13.5	4.5	21.75	
716-25-26-15.5B	1/2 ID	75	90	9.25	4	15.5	26.25	24.75	12.62	25.88	13.5	4.5	21.75	
718-25-26-15.5G	3/8 ID	100	96	11.25	6	15.5	26.25	24.75	14.62	25.88	13.5	6.5	21.75	
718-25-26-15.5G	1/2 ID	100	96	11.25	6	15.5	26.25	24.75	14.62	25.88	13.5	6.5	21.75	
718-25-26-15.5 SD	3/8 ID	100	98	11.25	6	15.5	26.25	24.75	15.38	25.88	13.5	6.5	21.75	
718-25-26-15.5 SD	1/2 ID	100	98	11.25	6	15.5	26.25	24.75	15.38	25.88	13.5	6.5	21.75	
718-30-31-20D	3/8 ID	150	127	11.25	6	20	30.5	28.75	15.38	31.38	17	6.5	25.25	
718-30-31-20D	1/2 ID	125	127	11.25	6	20	30.5	28.75	15.38	31.38	17	6.5	25.25	